

Field Test Plan for TDD-LTE/LTE-A Synchronization using PTP

Calnex Sentinel

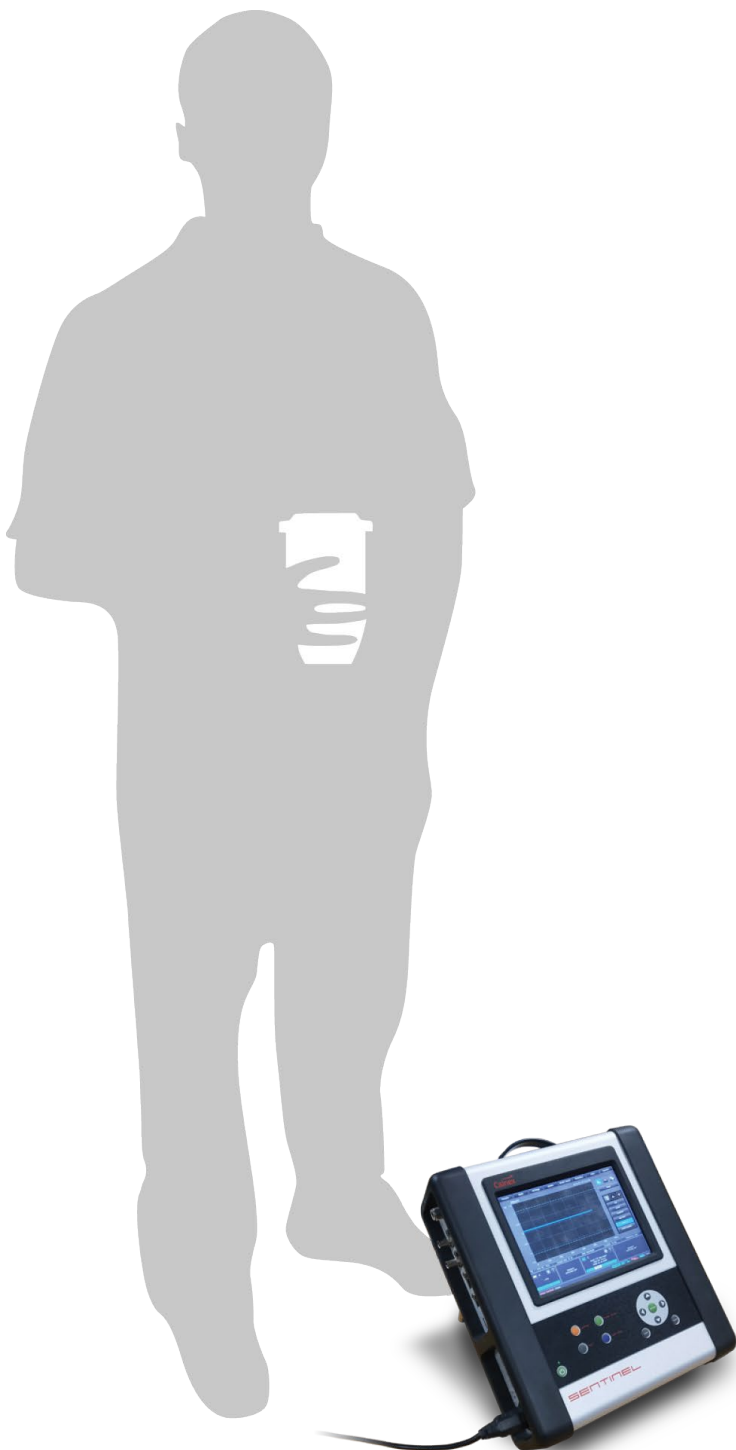

With the limited availability of frequency spectrum, TDD-LTE/LTE-A(MBSFN, CoMP, eICIC) networks are now being deployed to meet the demand for bandwidth. This adds a new requirement to provide highly accurate phase synchronization to the base stations, and as such, compliance to rigorous standards.

This document provides test procedures to ensure high quality phase/frequency for TDD-LTE/LTE-A networks running PTP protocol for timing synchronization. In the event of non-compliance, possible causes of failure, impact on the network, and suggested remedial actions are included to help field engineers understand and troubleshoot network issues more efficiently.

Contents

1	Background	3
2	Test Setup	4
3	Sentinel Configuration	5
3.1	1pps Output	5
3.2	PTP Connections	5
3.3	Configuring Sentinel Operating Mode	5
3.4	Time Base Settings	6
3.5	Measurement Settings	6
3.6	PTP Mode	7
3.7	Signal Check	8
3.8	Start the Test	9
4	Measurement Results Display	10
5	Test Cases	12
5.1	ITU-T G.8271.1 Network Limits	12
5.2	Maximum Time Error (max TE)	15
5.3	Dynamic Time Error (dTE)	17
6	Test Results Interpretation	20
7	Offline Analysis and Report Generation using CAT	21
Appendix A: PTP Synchronization Technology		22
Appendix B: ITU-T G.8271.1 Network Reference Model and Limits		23
Appendix C: Example Generated Report		25

 **Note:** Measurement data shown in this document can also be imported to the Calnex Analysis Tool (CAT) for more detailed analysis. CAT is available on all Calnex Paragon and Sentinel products.



1 Background

The migration from 3G to FDD-LTE was seamless with regards to the backhaul network as only frequency synchronization to the base stations was required. TDD-LTE, on the other hand, requires precise phase synchronization to the base stations which necessitates the deployment of PTP¹ and Global Navigation Satellite System (GNSS) receivers.

The performance of phase synchronization must be measured and monitored as non-compliance to standards will result in mobile service issues, including poor data transfer and re-transmissions, as well as dropped calls and failed handovers.

The network limits for phase synchronization are defined as:

- Maximum Time Error² (Max |TE|), which should be less than 1.1 μ s.
- Dynamic Time Error² (dTE), which should meet the Maximum Time Interval Error (MTIE) mask.

The following table describes the phase/time/frequency synchronization specifications for the packet mobile backhaul and the Air interface.

 **Note:** LTE-A technologies like MBSFN, CoMP and eICIC have similar demands for phase sync as shown in the table below. As such, the network limits mentioned above and this test plans apply to LTE-A as well.

Application	Frequency	Time	Packet Backhaul Spec
CDMA2000	± 50 ppb	± 3 to 10 μ s	
TD-SCDMA	± 50 ppb	± 1.5 μ s	
GSM	± 50 ppb	n/a	± 16 ppb (G.8261.1)
WCDMA	± 50 ppb	n/a	± 16 ppb (G.8261.1)
LTE (FDD)	± 50 ppb	n/a	± 16 ppb (G.8261.1)
LTE (TDD)	± 50 ppb	± 1.5 μ s (< 3km cell radius) ± 5 μ s (< 3km cell radius)	± 16 ppb (G.8261) ± 1.1 μ s (for ± 1.5 μ s G.8271.1)
LTE-A MBSFN	± 50 ppb	± 1 to 5 μ s Implementation dependent	± 16 ppb (G.8261.1) ± 1.1 μ s (for ± 1.5 μ s G.8271.1)
LTE-A CoMP	± 50 ppb		
LTE-A eICIC	± 50 ppb		
Small Cells	± 100 ppb	n/a (FDD) ± 1.5 μ s (TDD) ± 1 to 5 μ s (eICIC)	± 33 ppb ± 1.1 μ s (for ± 1.5 μ s G.8271.1)
Home Cells	± 250 ppb	n/a (FDD) ± 1.5 μ s (TDD)	± 100 ppb ± 1.1 μ s (for ± 1.5 μ s G.8271.1)

 **Note:** TDD-LTE mobile backhaul for example, the requirement is ± 16 ppb for frequency stability as per G.8261.1 recommendation, and ± 1.1 μ s for phase stability as per G.8271.1 recommendation.

¹ See Appendix A

² See Appendix B

2 Test Setup

Typical field test setup using the Sentinel is shown below.

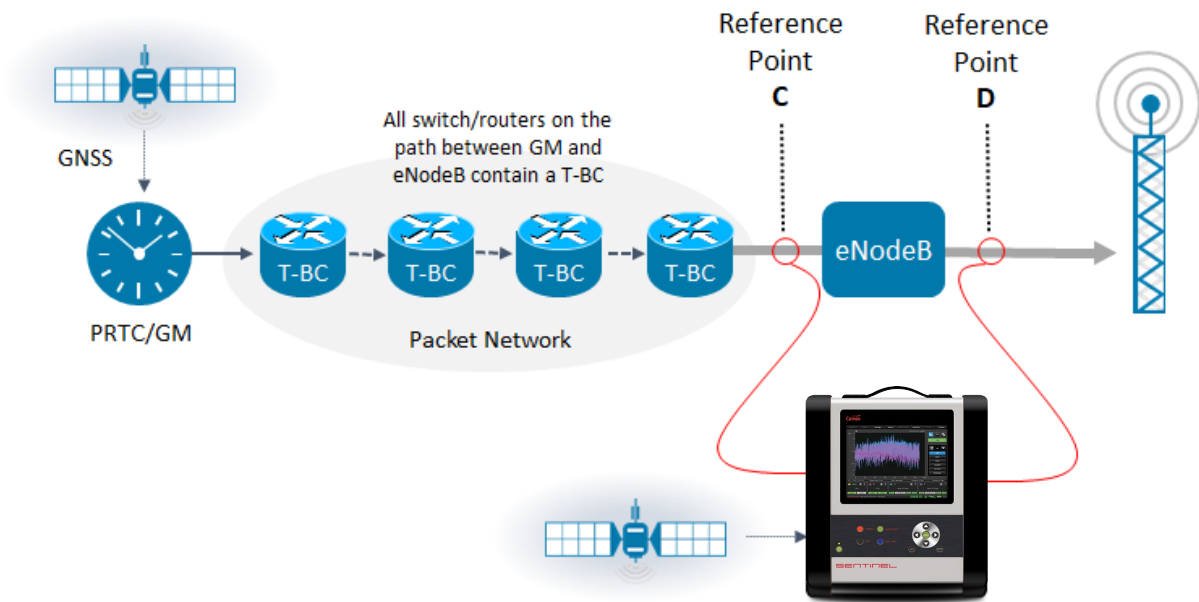

3 Sentinel Configuration

Before performing any measurements, follow the steps below to configure the Sentinel.

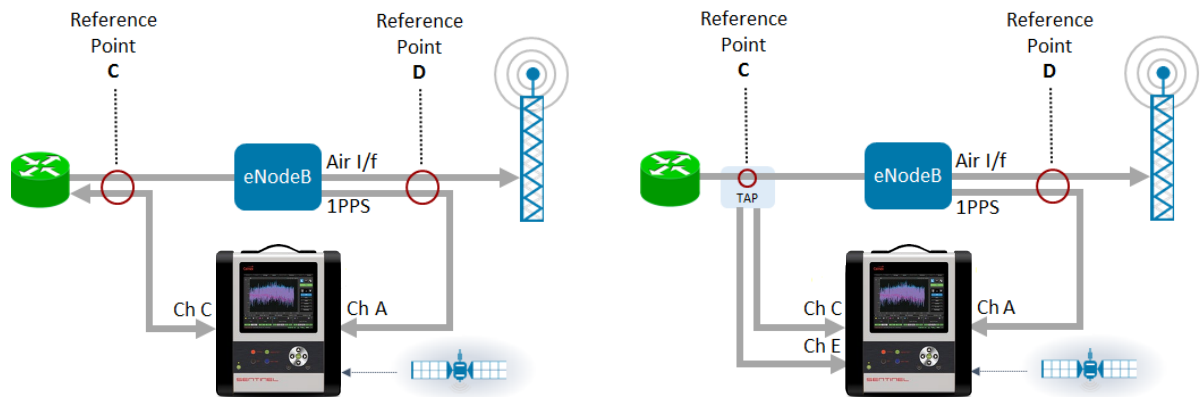

3.3 Configuring Sentinel Operating Mode

This test requires one Sentinel clock channel and either a single PTP channel running as a Pseudo Slave or two PTP channels running in PTP Monitor mode. Sentinel is configured for these tests from the Mode tab on the main screen.

Select the appropriate clock channel (in this case Channel A) and for PTP either select SyncE / PTP Slave or PTP Monitor Mode. Press **OK**.

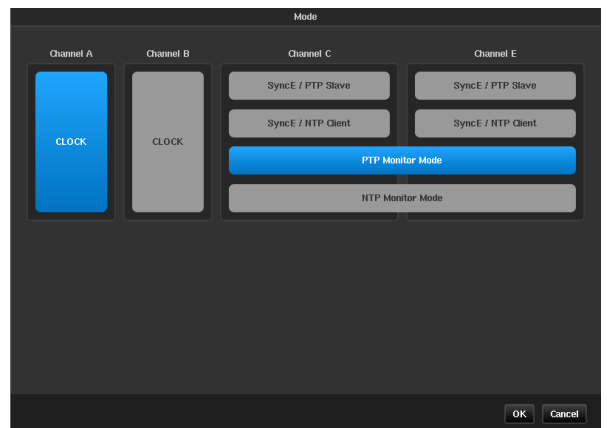
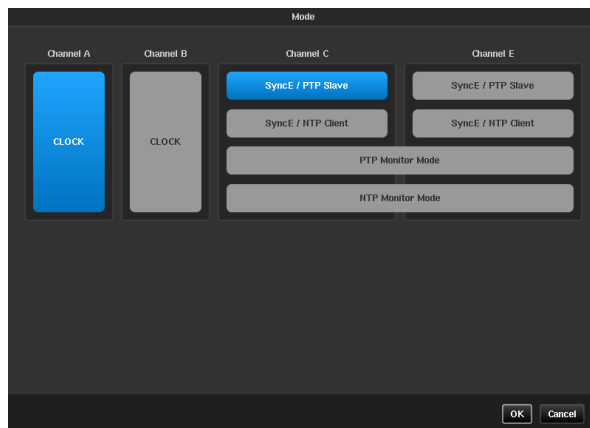

3.4 Time Base Settings

From the Measurement tab on the Settings page, set Sentinel to use the internal clock as time base reference and choose GNSS signal as the internal reference disciplining source. Set the Measurement Start Behavior to **Wait till Timebase Reference is ready**, and the Internal Reference Disciplining Mode to **Always**

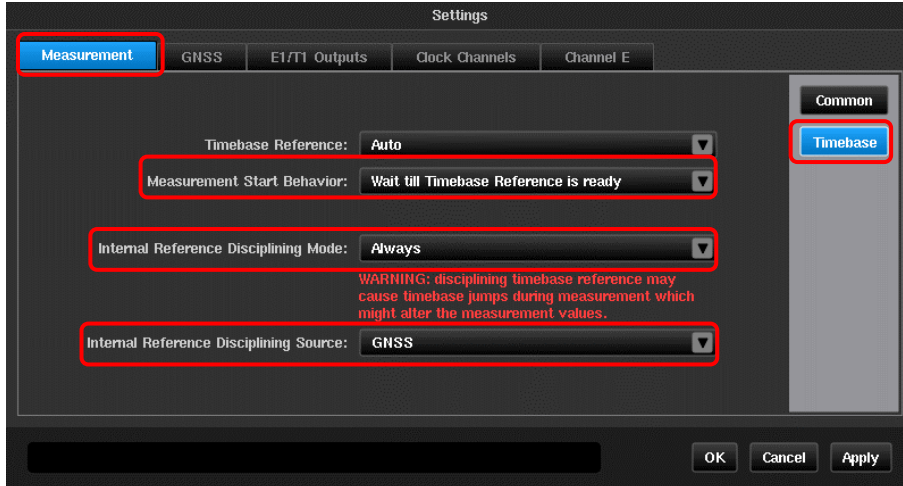

From a cold start, it takes around 15 minutes for Sentinel internal Rubidium to warm up. With GPS signal connected, the GPS receiver needs to lock to at least 3 satellites before it can output valid reference to Rubidium for disciplining. The GPS receiver will continue to output a valid reference while it is locked to at least three satellites.

In case of no GPS signal availability at the test site, Sentinel's internal Rubidium can be trained in advance and the battery in the Sentinel used to retain the Rubidium phase and frequency information in holdover during transportation from lab to the field. It is recommended to train the Rubidium in the lab for at least 12 hours if training has not been performed in the last week, or 6 hours if training has taken place in the last week.

To put the Sentinel in Transport Mode, from Sentinel front panel, press on  button. The following window will be displayed. Click on "Transport Mode" to enable battery backup of the Rubidium.

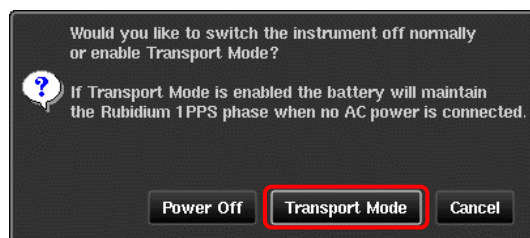

While AC power is applied to Sentinel the Rubidium is powered from this and will automatically switch over to the battery when AC power is removed. It is recommended to limit the time in transport mode to under 3 hours. When AC power is supplied again, the Rubidium will be powered by this and the battery will be re-charged.

3.5 Measurement Settings

1. From the "Measurement > Common" tab, select Mode: **TIE + PDV** and TIE Mode: **TIE + 1pps TE**.

- Set Diff TIE reference: **1 PPS Ref**, set TIE mask: **On** and TIE mask value: **1.35 μ s**.
- Set test duration. The recommended test duration is 10000s. However, if intermittent issues occur in the network in a less frequent manner, a longer test duration may be required in order to capture the intermittent issues.

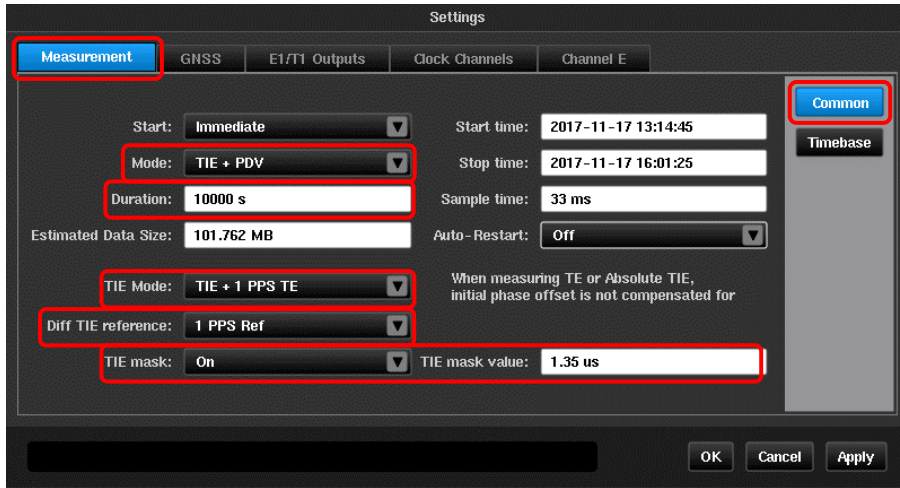

3.6 PTP Mode

Sentinel can work either in Pseudo-slave Mode, or Monitor Mode. Choose one of the following configuration procedures dependent on the mode Sentinel is operating in.

- Pseudo-slave Mode:** Sentinel connects to a cell site router.
- Monitor Mode:** Sentinel connects to a TAP or a splitter.

3.6.1 Pseudo-slave Mode

From the Settings->Channel C->PTP page select the **G.8275.1 Time/Phase Profile**. This fills the PTP configuration fields with default values relevant to the G8271.1 test. Ensure that the **Domain** is correct for the GM being tested.

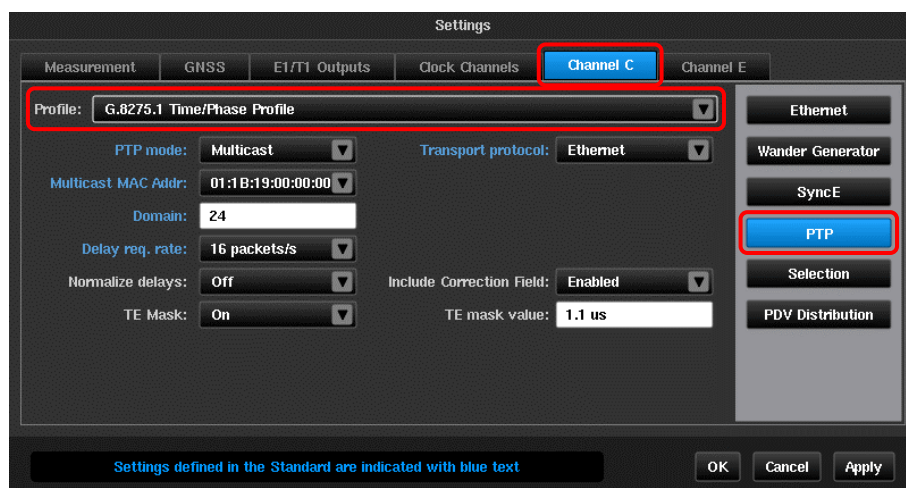

Additionally the Pseudo Slave network related parameters should be set in the Settings->Channel C->Ethernet page. Ensure that the media type, VLAN, PTP Slave IP address are configured correctly and have been provisioned for the test site.

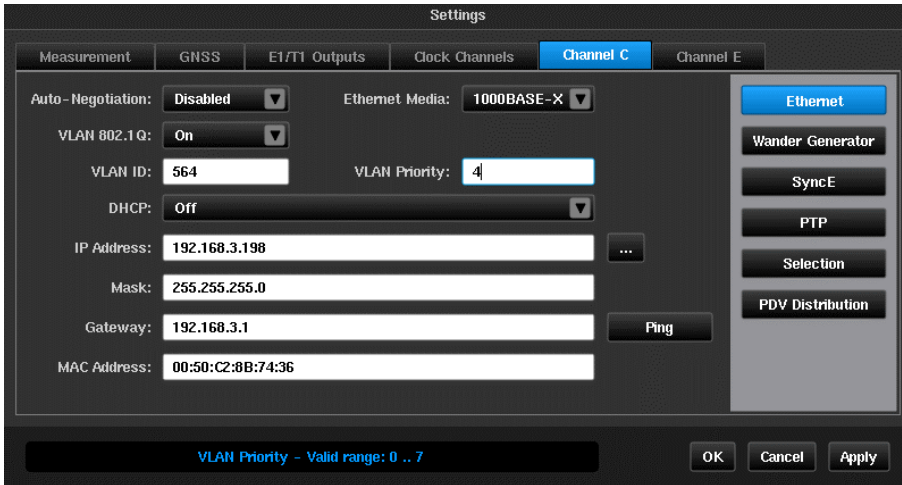

NOTE: this test uses Ethernet as the transport protocol and as such the IP configuration is not required. However if an IP address is set then the Gateway address must be on the same subnet.

3.6.2 Monitor Mode

If Sentinel is operating in Monitor Mode, then use the “**Discover...**” function on the Settings->Monitored Channels-> Monitor Mode page to automatically detect the Master/Slave. The system will automatically update the Master/Slave settings per the discovery. Make sure to set up both Monitored Channels Ethernet parameters and turn the normalize delays **Off** from the drop down box.

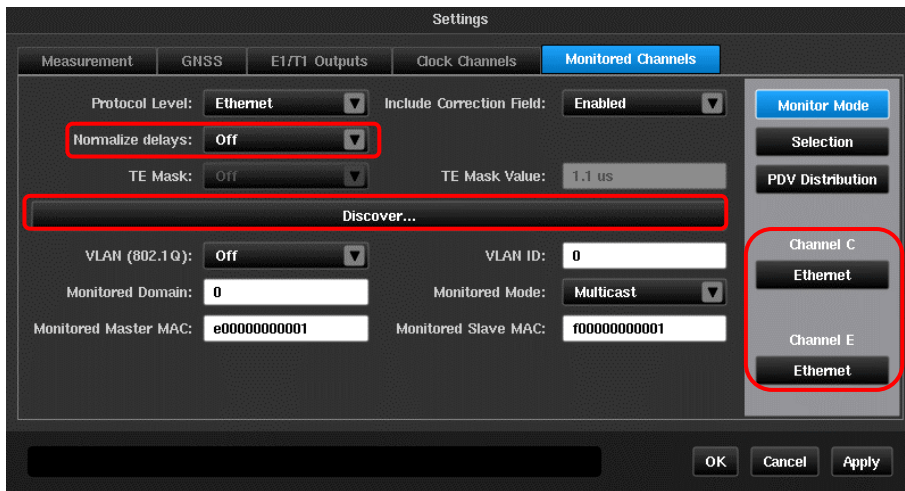

3.7 Signal Check

1. Click on the “Health Check” tab on the main screen and select “Signal Check” from the Health Check screen.
2. Make sure signal check detects the 1PPS from the T-TSC and there is an Ethernet link.

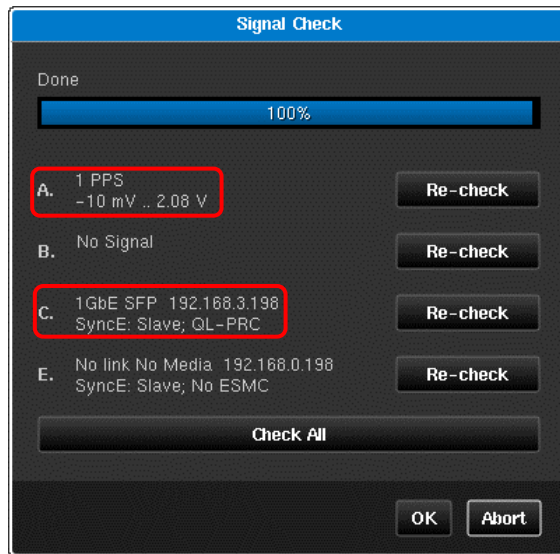

3.8 Start the Test

1. Click on the "Start" button.
2. Sentinel will prompt you to select where to store the measurement results. The results can be saved on either Sentinel or on an external USB stick.

Note: For long term measurements, it is always recommended to use external USB sticks for sufficient storage space.

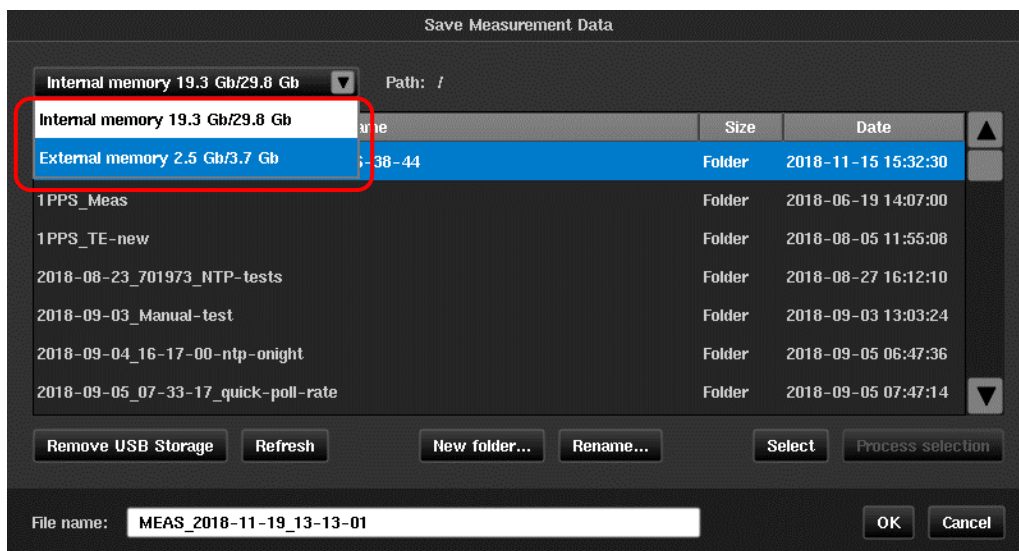

4 Measurement Results Display

Once the measurement starts, the graph of the 1pps time error (TE) with respect to the reference will be displayed on the main GUI window.

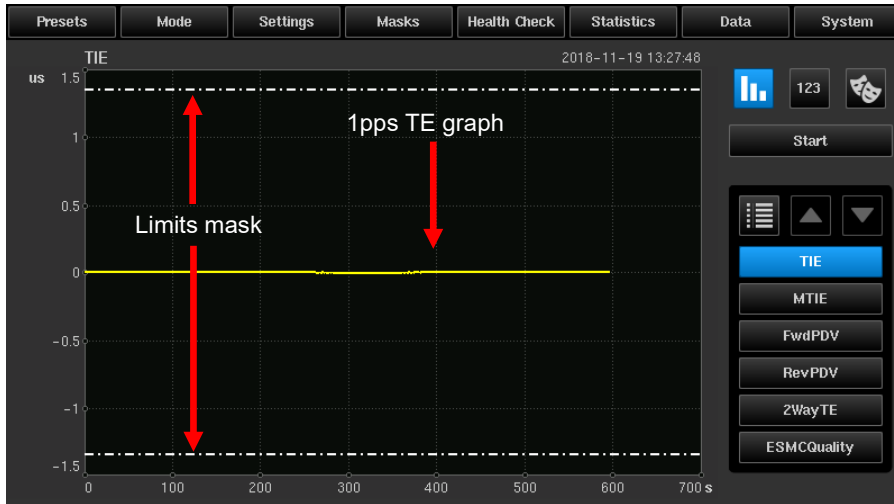

If the PTP GM and the Sentinel emulated Slave establishes the session successfully, the status of the PTP flow is shown in the channel widget.



The full channel status, including the negotiated parameters can be displayed by pressing the **i** button.

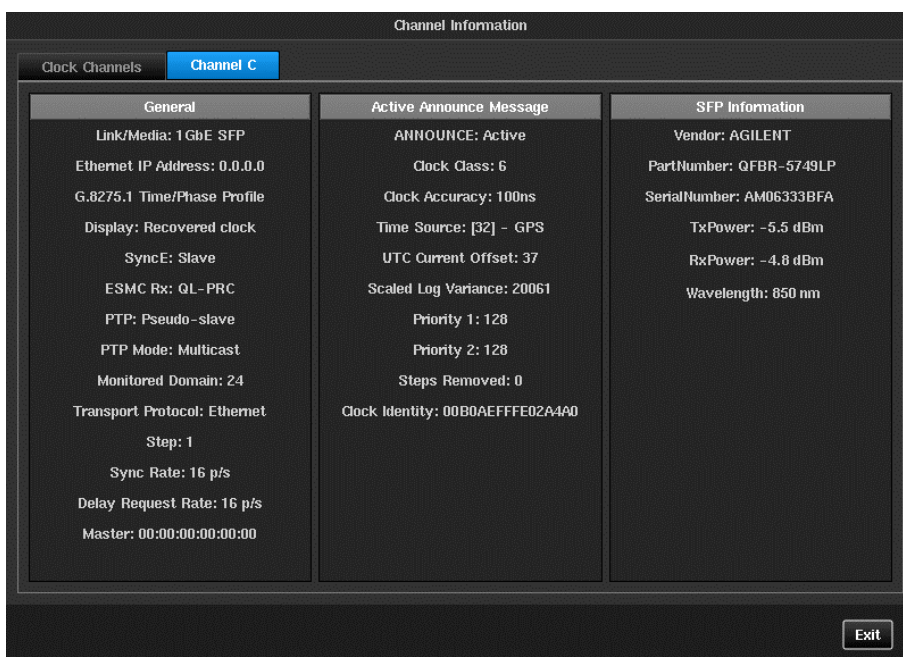

The forward and reverse delays and 2way Time Error are also graphed. To view the forward delay, reverse delay or 2way Time Error, click on the Fwd PDV, Rev PDV and 2 way TE buttons.

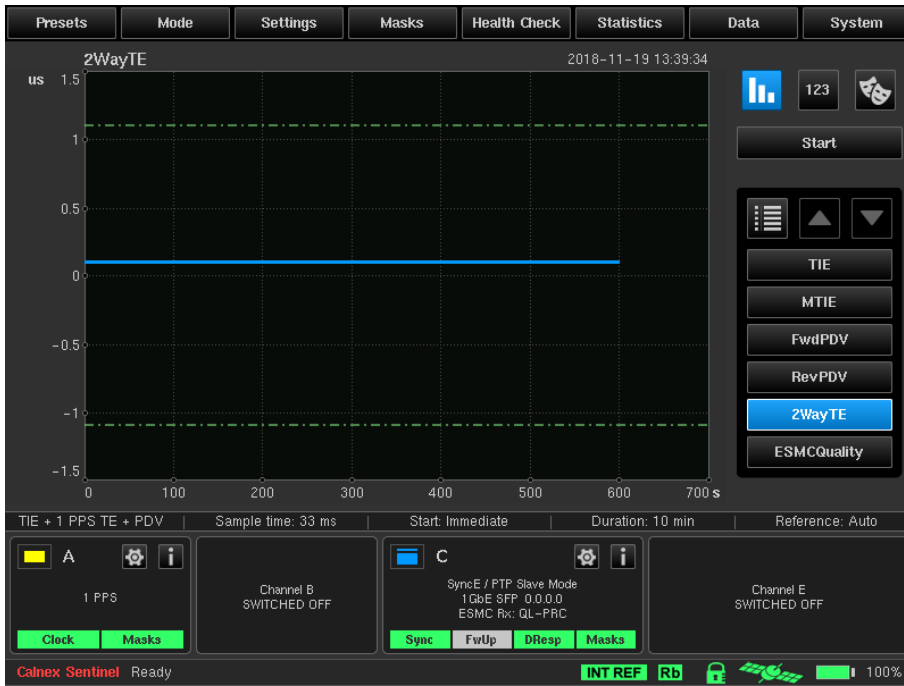

5 Test Cases

5.1 ITU-T G.8271.1 Network Limits

ITU-T G.8271.1 defines the following metrics and limits at reference point C and D.

- Maximum absolute TE: $\max |TE|$, which includes the constant TE and the low frequency components of the dynamic TE
 - $\max |TE| \leq 1\,100\text{ ns}$;
- Dynamic low frequency TE network limit: specified in terms of MTIE

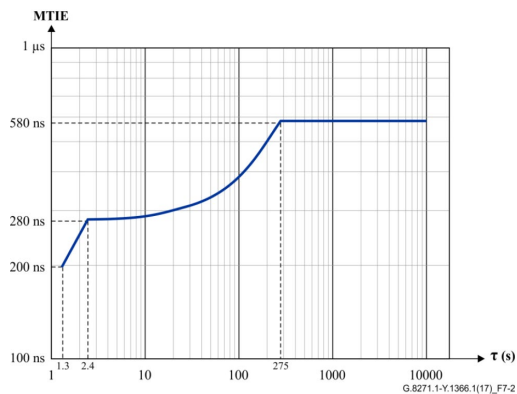

- Dynamic high frequency TE (frequency components higher than 0.1 Hz) measured over a 10 000 s interval:
 - peak-to-peak TE amplitude < 200 ns

5.1.1 Selecting ITU-T G.8271.1 Metrics in CAT

By default CAT will determine which metrics to display based on the type of measurement files that are loaded. This can lead to clutter and may indicate a false failure on metrics and limits that are not specific to ITU-T G.8271.1.

Copy the measurement files from Sentinel to the PC that CAT is running from. Either open all the .dset files from CATs Select File tab or drag and drop all the .dset files onto the CAT window.

Sentinel generates the following .dset files:

- channelX.dset – Raw TIE data for a clock or reference channel
- channelX_ESMC_QUALITY.dset – SyncE SSM message transitions
- channelX_FWD_PDV.dset – Raw PDV calculated from PTP Sync messages
- channelX_REV_PDV.dset – Raw PDV calculated from PTP Delay Request / Delay Response messages
- channelX_2WAY_TE.dset – calculated PTP 2Way Time Error. This file is not used by CAT
- channelX_PATH_DELAY.dset – calculated PTP path delay.

Where X is the associated measurement channel A to F.

NOTE: Only channelA.dset, channelC_FWD_PDV.dset and channel_REV_PDV.dset need to be loaded to generate the ITU-T G.8271.1 metrics for this test setup. If the SyncE recovered clock is to be verified then channelC.dset should also be loaded.

NOTE: Sentinel generates .dset files that should not be loaded into CAT. The channel will correspond to that selected as the **Differential TIE reference** (F if set to 1PPS Ref). This file should not be included in the metrics check.

If any files other than those required for the metric were loaded then they can be de-selected or closed from the Select File page.

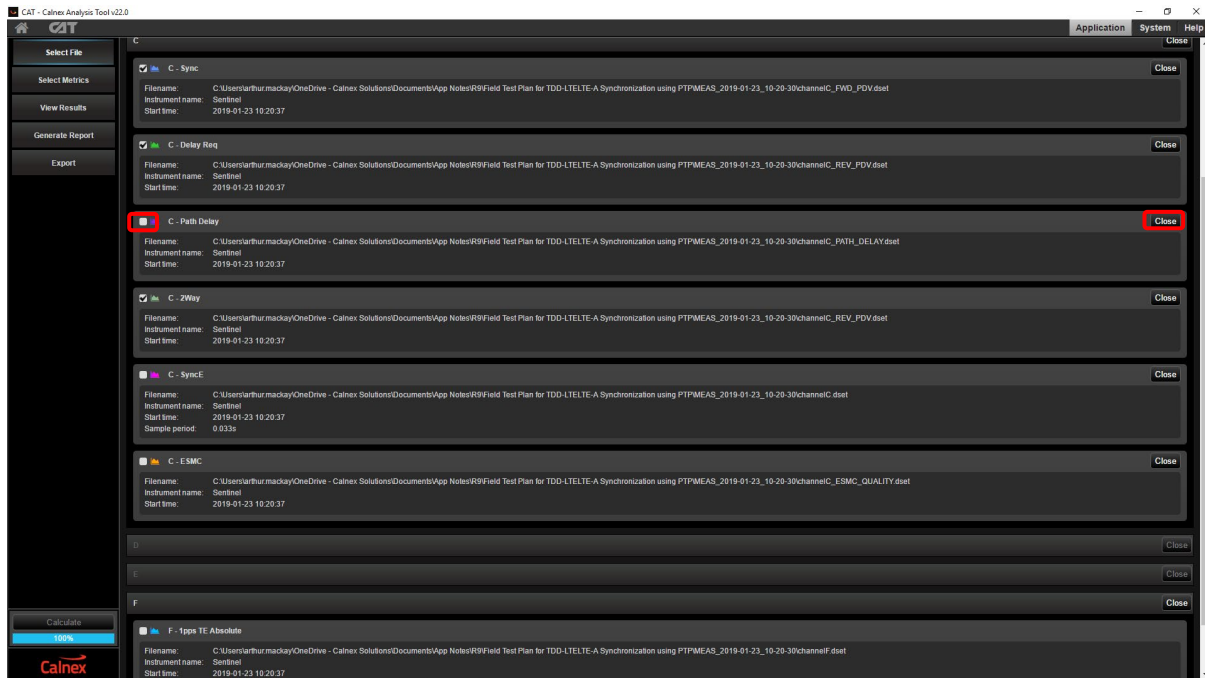

The relevant metrics can be enabled through the Select Metrics page:

Check / uncheck the metrics check boxes as shown:

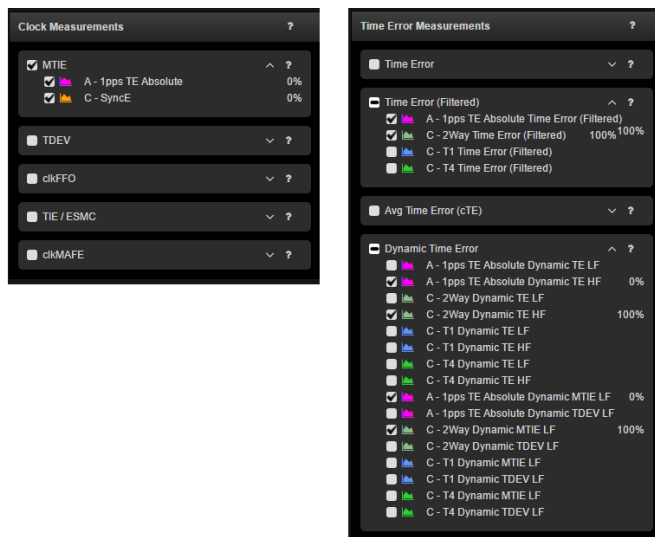

The clock measurements box should enable MTIE for the 1PPS and for SyncE if the recovered clock is to be tested.

The 1PPS max|TE| and PTP max|2WayTE| should be enabled in the Time Error (Filtered) section. This applies a 0.1Hz to the raw results for the 1PPS TE and the calculated 2WayTE from the FWD_PDV and REV_PDV files.

The 1PPS TE dynamic high frequency, 2WayTE dynamic high frequency, 1PPS TE dynamic LF MTIE and 2WayTE dynamic LF MTIE should be enabled in the Dynamic Time Error section.

All other metrics should be cleared. Press the Calculate button to generate the metric data.

The network limits are set from the graphs in the View Results page.

max |TE| limit is set at 1.1us for network point C on the Time Error (Filtered) results page.

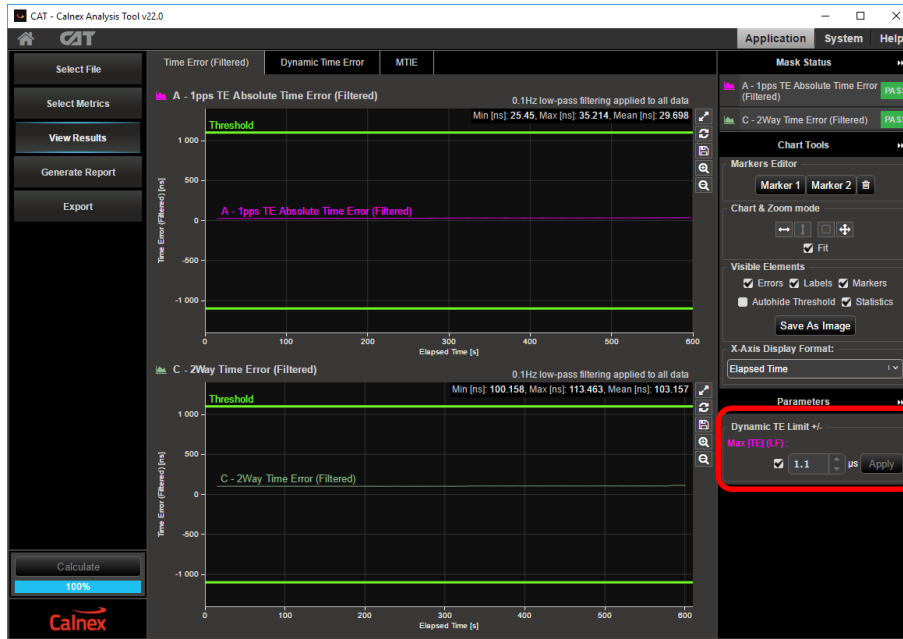

NOTE: The 1PPS TE may be representative of the output at network point D and in this case the limit should be set to 1.35 us.

The dynamic high frequency and dynamic low frequency MTIE limits are set on the Dynamic Time Error page



If there is a recovered clock at network point C then the limits can be set for this on the MTIE results page

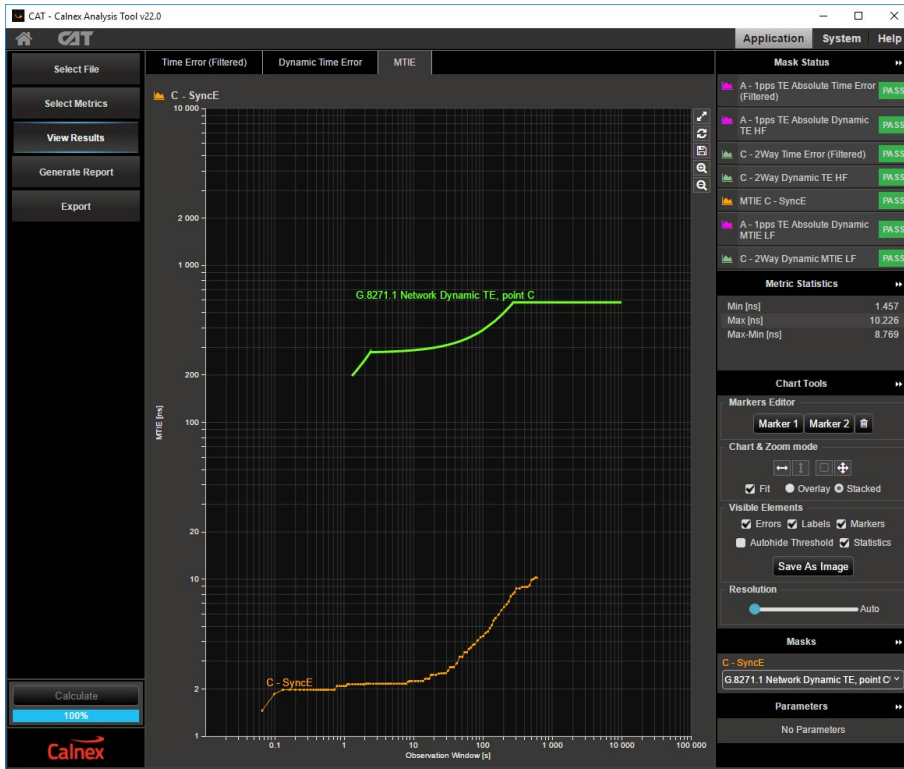

Selecting Generate Report will include all of the graphs relevant to an ITU-T G.8271.1 measurement.

5.2 Maximum Time Error (max |TE|)

5.2.1 Measure max|TE| at the 1pps signal output interface from eNodeB

The max |TE| can be measured at the 1pps signal output interface from eNodeB and compared with the 1.35 μ s mask. The example screenshot shows the 1pps accuracy measurement – max |TE| using the CAT.

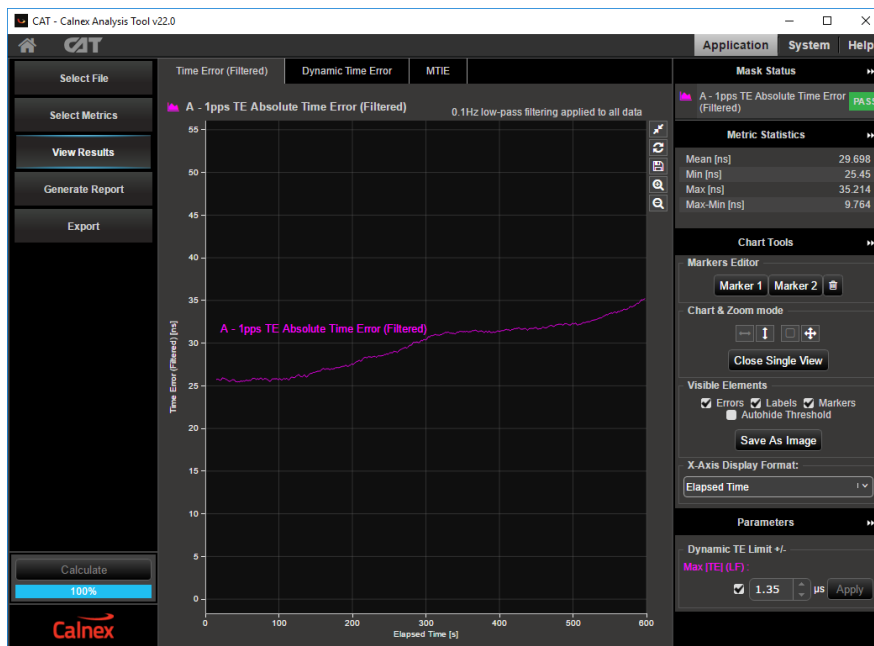

The measured max|TE| is within the range of +/- 1.35 μ s, therefore it passes

5.2.2 Measure max|TE| at PTP flow

The following example screenshot shows the max|TE| analysis using CAT. The pass/fail criteria can be specified on the right under Max TE limit +/- section. The pass/fail result is highlighted in either green for Pass or red for Fail and displayed under mask status section

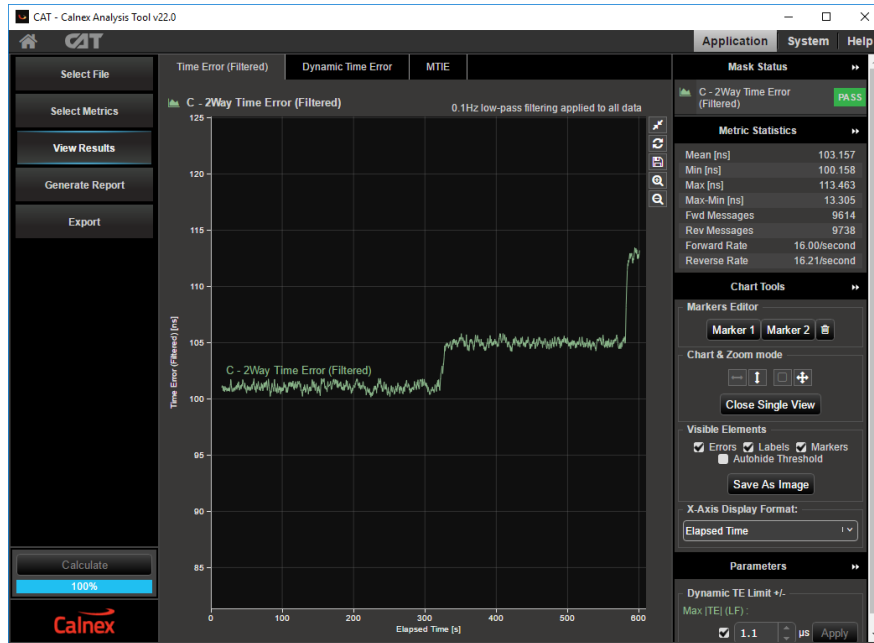

5.2.3 Sample max |TE| Test Results

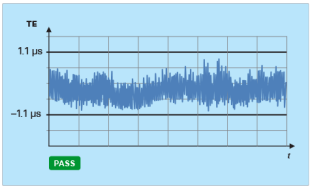
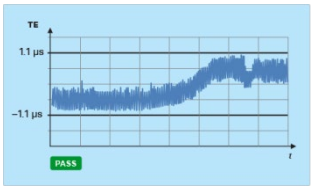
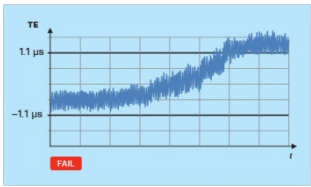
Example Results			
	Within TE limits - Pass	TE close to limits	TE outside limits - Fail
Possible Causes	n/a	n/a	<ul style="list-style-type: none"> • Network asymmetry • Cable asymmetry • Equipment TE
Possible Impact	n/a	n/a	<ul style="list-style-type: none"> • Dropped calls • Slow data transfer
Next Action	n/a	<ul style="list-style-type: none"> • Network is under stress • Need to closely monitor the network for traffic growth 	<ul style="list-style-type: none"> • Measure TE step by step • Locate where asymmetry comes from • Compensate by adding a fixed delay on the switch(s) and router(s)

5.3 Dynamic Time Error (dTE)

Dynamic Time Error can be measured in terms of MTIE at either the 1pps signal output interface, or at the frequency signal output (2M/10M/E1/T1) interface from the eNodeB, or with the PTP flow to eNodeB.

 **Note:** dTE can only be viewed using the CAT.

5.3.1 Measure dTE at the 1pps signal output interface from eNodeB

This following example screenshot shows a dTE measurement result at the 1pps signal out interface³. This graph is found on the CAT Dynamic Time Error tab.

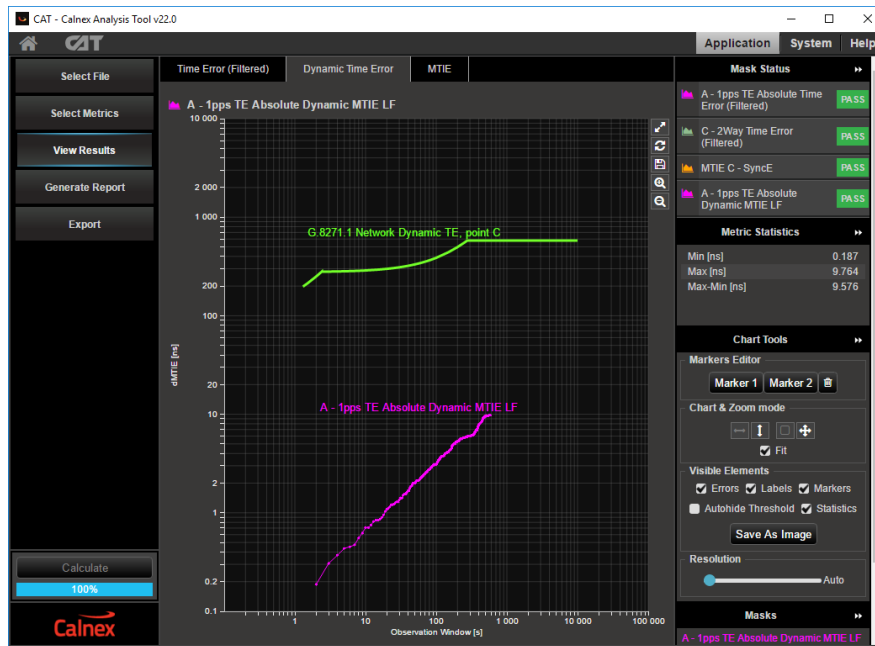

5.3.2 Measure dTE at PTP flow

This following example screenshot shows a dTE measurement result at PTP flow.

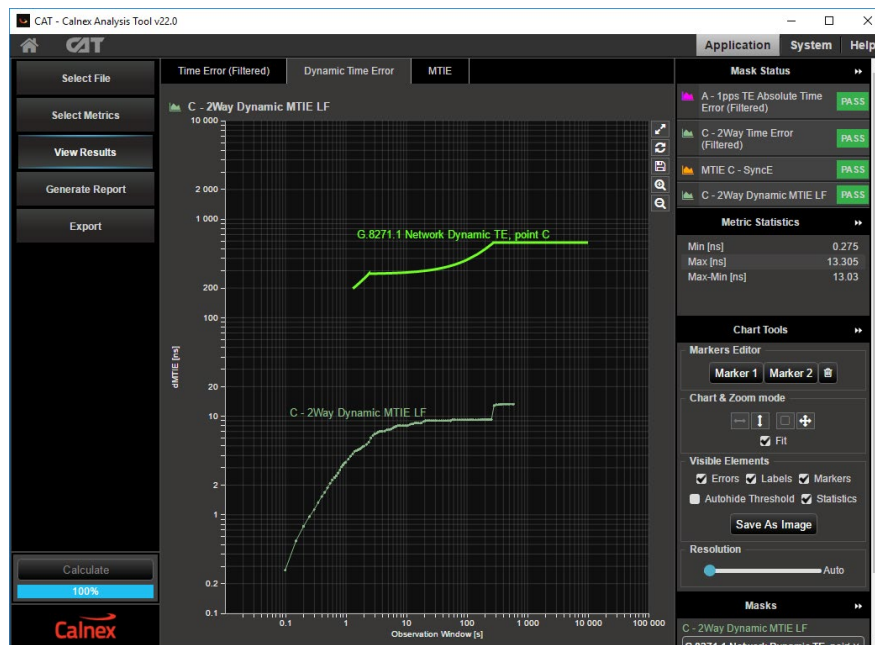

³ Using the CAT

5.3.3 Sample dTE Test Results

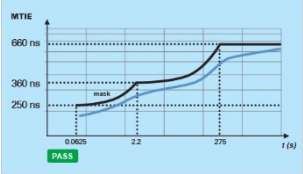
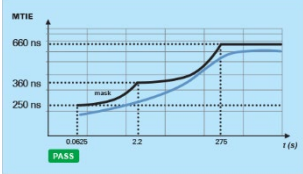
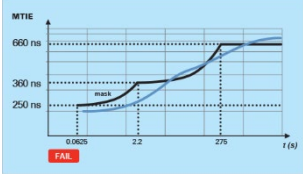
Example Results			
	Within limits	Close to limits	Fail
Possible Causes	n/a	n/a	<ul style="list-style-type: none"> TE in timestamps Poor performance of local oscillator Possible clock source transition in PTP and/or SyncE link caused by hardware failure
Possible Impact	n/a	n/a	<ul style="list-style-type: none"> Drop calls Slow data transfer
Next Action	n/a	<ul style="list-style-type: none"> Network is under stress Same actions as for Fail 	<ul style="list-style-type: none"> Check for re-arrangement event Check for number of hops between Grandmaster and Slave

6 Test Results Interpretation

The evaluation of the results should be in conjunction with both Max|TE| and dTE.

Max TE	dTE	Possible Causes and Actions
Pass	Pass	No problem identified.
Fail	Pass	<ul style="list-style-type: none"> • Network can deliver required frequency stability, but not the required phase accuracy • Network asymmetry may be too significant • Performance of PTP aware elements (Boundary and Transparent clocks) needs to be re-evaluated (equipment TE) • Delay compensation may be needed
Pass	Fail	<ul style="list-style-type: none"> • Number of hops between Master and slave might be too many • Re-arrangement event might have occurred • Performance of PTP aware elements (Boundary and Transparent clocks) needs to be re-evaluated (equipment TE)
Fail	Fail	<ul style="list-style-type: none"> • Network re-routing or re-engineering may be needed • Performance of PTP aware elements (Boundary and Transparent clocks) needs to be re-evaluated (equipment TE)

 **Note:** This test plan examined synchronization test of LDD-LTE networks using PTP technology. Please refer to other test documents from Calnex for frequency synchronization using NTP⁴ and frequency synchronization using PTP⁵.

⁴ Calnex document number CX5017

⁵ Calnex document number CX5018

7 Offline Analysis and Report Generation using CAT

The Calnex Analysis Tool (CAT) is a standalone software tool from Calnex for comprehensive metrics analysis with pass/fail masks integrated. The captured raw data from Sentinel can be imported to CAT for such metric analysis. More importantly, professional report can be generated by one click from CAT after the analysis.

Refer to section 5.1.1 on how to import data from Sentinel to CAT and select the relevant ITU-T G.8271.1 metrics and limits.

To generate professional reports⁶, simply click on “Generate Report” button.

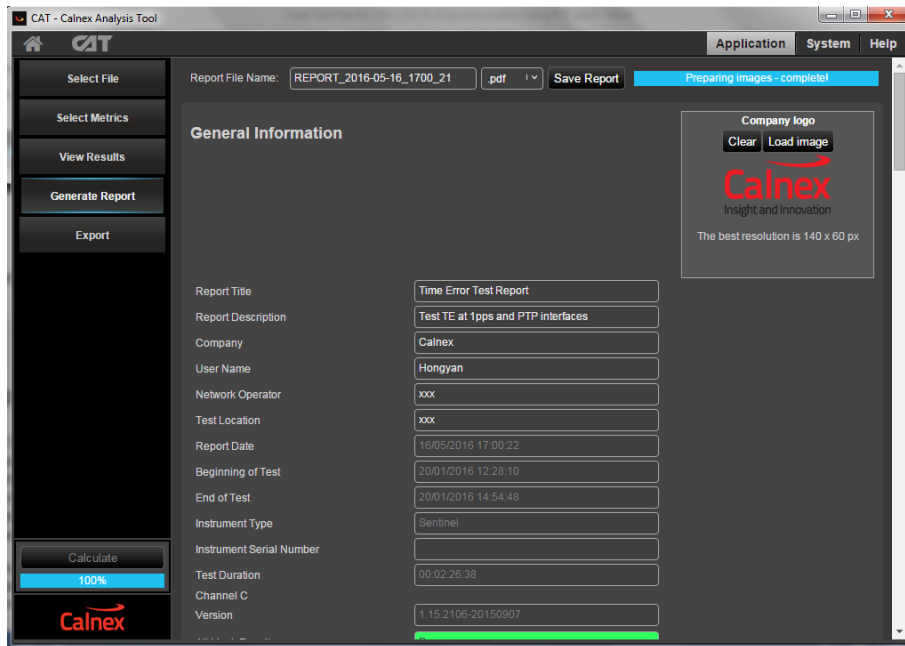

⁶ See Appendix C for example report

Appendix A: PTP Synchronization Technology

IEEE1588v2 (also known as Precision Time Protocol, PTP) is an industry-standard protocol that enables the precise transfer of frequency and time to synchronize clocks over packet-based Ethernet networks. It synchronizes the local slave clock on each network device with a system Grandmaster clock and uses traffic time-stamping, with sub-nanoseconds granularity, to deliver the very high accuracies of synchronization needed to ensure the stability of base station frequency and handovers. Timestamps between master and slave devices are sent within specific PTP packets and in its basic form the protocol is administration-free.

Of course, the precision and performance of the PTP protocol is based on the precision of the timestamp. The timestamps of incoming and outgoing packets clearly need to be recorded and assessed to ensure synchronization of master and slave devices. Differences in time and frequency between clocks and subsequent equipment corrections need to be evaluated, while clocks must be measured to ensure they are within their specified limits. Further, delays and drifts in synchronization and their effect on the transfer of timing through the network need to be considered too. Here, we examine the precision of timestamp synchronization, as well as the accuracy of clocks under various network scenarios, before deploying equipment in an operational network.

There are two types of message in the PTP protocol: Event Messages and General Messages. Event Messages are timed messages whereby an accurate timestamp is generated both at transmission and receipt of the message. General Messages do not require timestamps but may contain timestamps for their associated event message.

Events Messages include Sync, Follow-up, Delay-Request and Delay-Response. The PTP work flow is shown below.

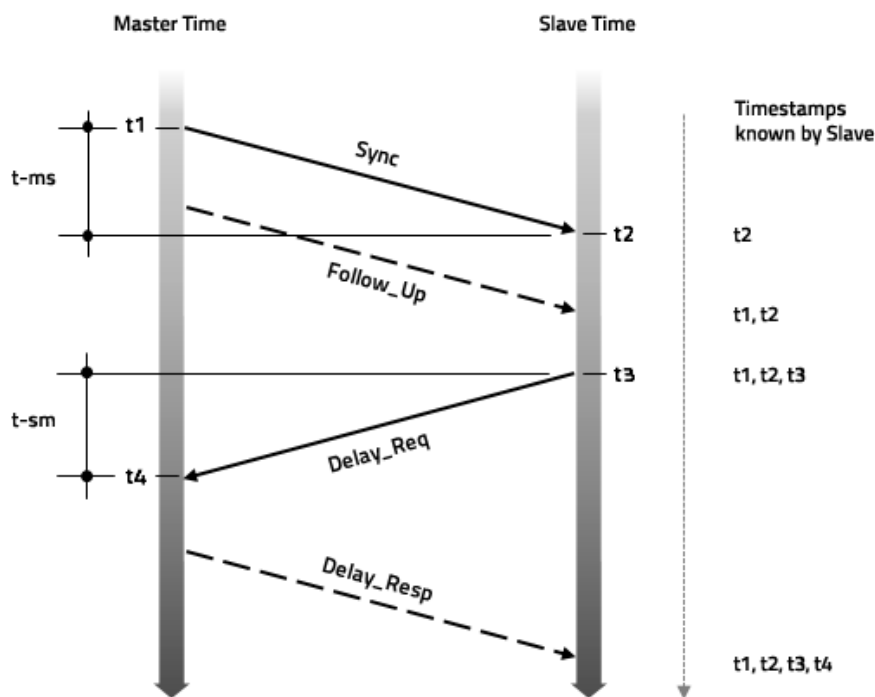

Once the Slave knows the timing of t_1 , t_2 , t_3 , and t_4 , it can calculate the mean propagation delay (Tmpd) of the message path and slave clock offset. This can be calculated by:

- $Tmpd = ((t_2 - t_1) + (t_4 - t_3)) / 2$
- $Offset = t_2 - t_1 - Tmpd$

Appendix B: ITU-T G.8271.1 Network Reference Model and Limits

Reference points are used on time synchronized packet networks. At each reference point, the network time error limits are defined.

The packet network reference model is shown below.

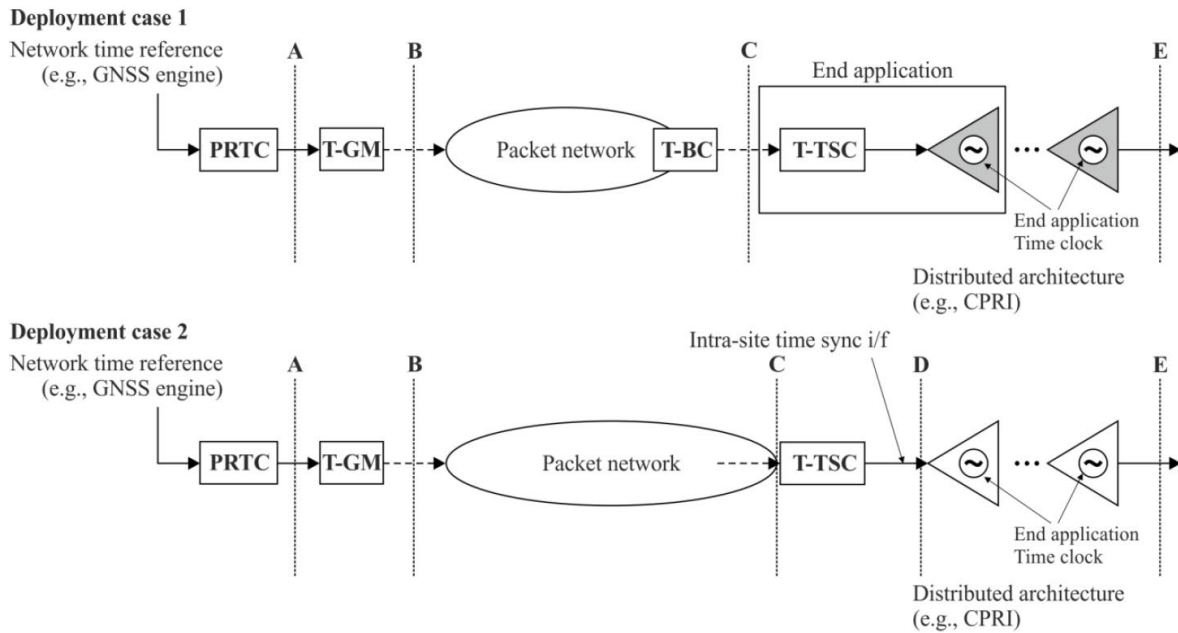

For TDD-LTE applications, the network limits applicable at reference point C are expressed in terms of three quantities:

- Maximum absolute TE: $\max |TE|$, which includes the constant TE and the low frequency components of the dynamic TE
- Dynamic low frequency TE network limit: specified in terms of MTIE
- Dynamic high frequency TE (frequency components higher than 0.1 Hz) measured over a 10 000 s interval

In the ITU-T G.8271.1 budgeting example/network reference model below, the maximum absolute time error⁷ network limit applicable at the reference point C is $\max |TE| \leq 1.1 \mu\text{s}$ and $\leq 1.35 \mu\text{s}$ at point D.

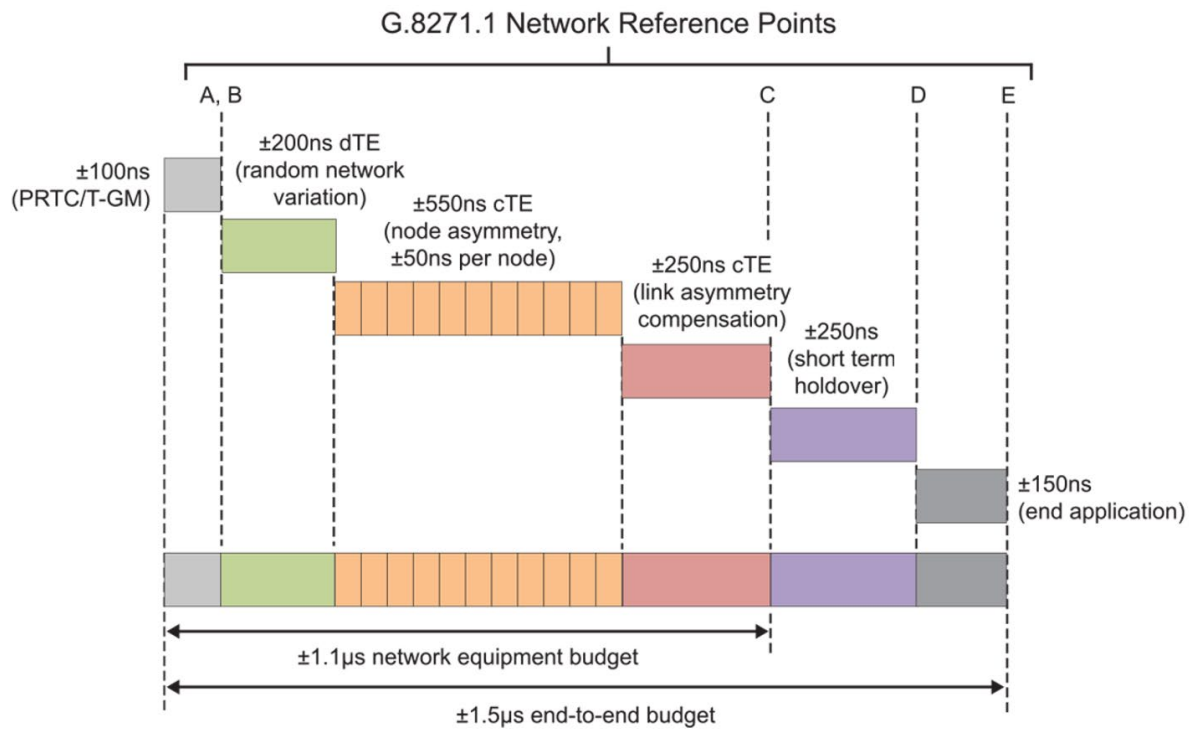

The network limit for dynamic low frequency at reference point C is specified in term of MTIE as below.

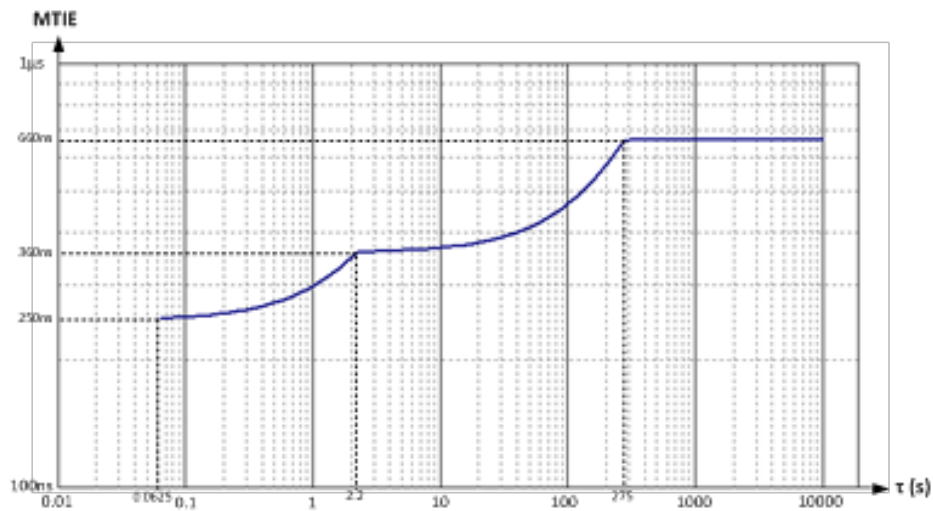

The high frequency TE peak-to-peak amplitude should be $< 200 \text{ ns}$

⁷ Phase accuracy is end-to-end Time Error

Appendix C: Example Generated Report

General Information

Report Title	ITU-T G.8271.1 Test Report
Report Description	Test 1PPS and PTP interfaces
Company	Calnex Ltd
User Name	Arthur
Network Operator	---
Test Location	---
Report Date	2019-01-23 12:28:31
Beginning of Test	2019-01-23 10:20:37
End of Test	2019-01-23 10:30:38
Test Duration	00:00:10:01
Instrument Type	Sentinel
Instrument Serial Number	701973
Software Version	2.9.1.0.43160-20190118
CAT Version	22.0.18330.538 [S]

Mask results:

All Mask Results	Pass
Mask A Time Error (Filtered) Result	Pass
Mask A Dynamic MTE HF Result	Pass
Mask A Dynamic MTE LF Result	Pass
Mask C Time Error (Filtered) Result	Pass
Mask C Dynamic TE HF Result	Pass
Mask C Dynamic MTE LF Result	Pass
Mask C MTIE Result	Pass

Instrument Test Configuration

Frequency Reference Source	Internal - Rb
----------------------------	---------------

Channel A Test Configuration

Network / Device Under Test	
1pps TE Absolute Sample Rate	1

Channel C Test Configuration

Network / Device Under Test	
Physical Medium/Line Rate	1GbE SFP
Encapsulation	Ethernet
Sync Pkt Rate	16
Delay Req Pkt Rate	16
Sync Sample Rate	1
Slave Address	192.168.1.198
Domain	24
VLAN Id	
Two-Step	False
Unicast / Multicast	Multicast

Master Information

gmIdentity	00B0AEFFFE011A8D
gmClockQuality.clockClass	0

Page 1 of 9

Results

1pps TE Absolute Measurement

Channel	A
Description	
Measurement Start	2019-01-23 10:20:37
Measurement Stop	2019-01-23 10:30:35
Mask Time Error (Filtered)	1.35 us
Mask Result	Pass
Mask Dynamic TE HF	0.2 us
Mask Result	Pass
Mask Dynamic MTIE LF	G.8271.1 Network Dynamic TE: point C
Mask Dynamic MTIE LF Result	Pass

Time Error (Filtered) Analysis

Mean [ns]	25.698
Min [ns]	25.45
Max [ns]	35.214
Max-Min [ns]	9.764

Page 3 of 9

MTIE LF Analysis

Min [ns]	0.167
Max [ns]	3.764
Max-Min [ns]	3.576

Page 5 of 9

2Way Measurement

Channel	C
Description	
Physical Medium	
Line Rate	
Measurement Start	2019-01-23 10:20:37
Measurement Stop	2019-01-23 10:30:37
Mask Time Error (Filtered)	1.35 us
Mask Result	Pass
Mask Dynamic TE HF	0.2 us
Mask Result	Pass
Mask Dynamic MTIE LF	G.8271.1 Network Dynamic TE: point C
Mask Dynamic MTIE LF Result	Pass

Time Error (Filtered) Analysis

Mean [ns]	163.157
Min [ns]	100.158
Max [ns]	113.693
Max-Min [ns]	13.305
Fwd Messages	9514
Rev Messages	9738
Forward Rate	16.00/second
Reverse Rate	16.21/second

Page 6 of 9

Calnex Solutions Ltd
Oracle Campus
Linlithgow
West Lothian EH49 7LR
United Kingdom

t: +44 (0) 1506 671 416
e: info@calnexsol.com

calnexsol.com

© Calnex Solutions Ltd, 2019
This document is subject to change without notice.

CX5019 v2.0 January 2019

